

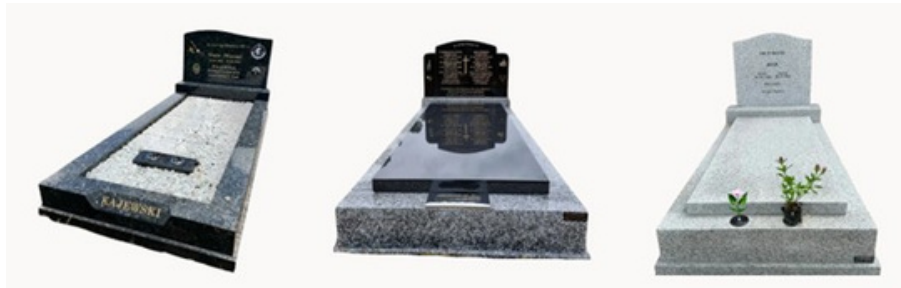

# Section A Burial Option - Monuments

Choose from a range of monuments that have been designed to celebrate and resemble the life of your loved one. Full Monuments range from single to double with a wide selection of colours to suit any style. A range of accessories include photos, vases and much more can be added to give your own personal touch. Height Restriction - 2 metres.

All monuments and plaques are coordinated by Kandanga Cemetery Association . In the case of monumental graves, clients are connected with the supplier direct.



## Section A Burial Option - Monument

Description	GST	Fee incl GST	Total at time of application
Burial Rights Section A (Refundable)	N/A	\$1,000.00	
Perpetual Maintenance (Non Refundable)	10%	\$ 500.00	
Interment	10%	3,020.00	
Supply and Install Granite Memorial 1200mm wide X 2400mm long. Max 2m H	10%	Price on Application	
Etching or Font 0 - 100 Characters 100 - 200 Characters	10%	\$500.00 \$750.00	Optional for images Vitreous, Ceramic or etched images - POA
Supply & Install Additional Memorial Plaque	10%	\$300.00	<b>ADDITIONAL EXTRAS</b>
Additional Ashes Placement	10%	\$200.00	
Administration for each additional placement	10%	\$200.00	



## KANDANGA CEMETERY ASSOCIATION INC

PO Box 102  
2325 Mary Valley Road  
KANDANGA QLD 4570  
Phone: 0438843195  
Email: secretary@kandangacemetery.com.au

Prices include Australian Standard concrete foundations & installation as per Australian Standard AS4204/2019

Fees reviewed annually 1 January - Current 01.01.26 - 31.12.26



# Section A Burial Option - Upright

Our headstones are designed to celebrate and resemble the life of your loved one, these range from single to double with a selection of colours available.

A range of accessories include photos, vases and much more can be added to give your own personal touch.

All monuments and plaques are coordinated by Kandanga Cemetery Association . In the case of monumental/graves, clients are connected with the supplier direct.

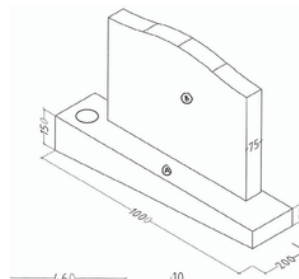
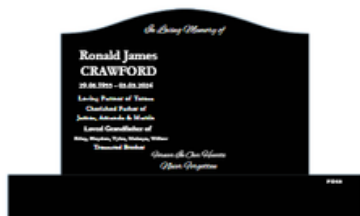

## Section A Burial Option - Upright

Description	GST	Fee incl GST	Total at time of application
Burial Rights Section A (Refundable)	N/A	\$1,500.00	
Perpetual Maintenance (Non Refundable)	10%	\$ 500.00	
Interment	10%	\$3,020.00	
Supply & Install Granite Headstone and Base	10%	\$2930.00	
Etching or Font 0 - 100 Characters	10%	\$500.00	Optional for images. Vitreous, Ceramic or etched images - POA
100 - 200 Characters		\$750.00	
Supply & Install Additional Memorial Plaque	10%	\$300.00	ADDITIONAL EXTRAS
Additional Ashes Placement	10%	\$200.00	
Flower Holder	10%	150.00	
Administration for each additional placement	10%	\$200.00	

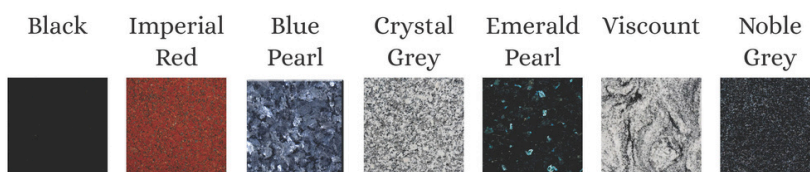



# Section A Burial Option - Desktop

Desktop Headstones mark the location of a burial and can be dedicated to one or two family members, commemorated with a granite marker. Additionally, up to five ash inurnments can be included, each with a bronze plaque.

One or two flower inserts can be added to the desktop headstone. The base is angled to accommodate the natural slope of the ground.

All monuments and plaques are coordinated by Kandanga Cemetery Association. In the case of monumental graves, clients are connected with the supplier direct.

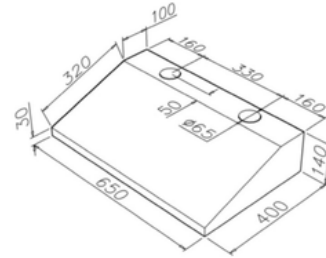
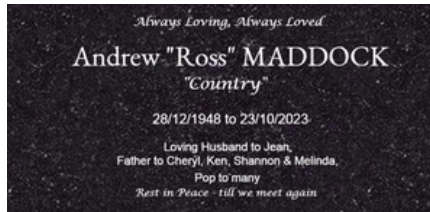

## Section A Burial Option - Desktop

Description	GST	Fee incl GST	Total at time of application
Burial Rights Section A (Refundable)	N/A	\$1,000.00	
Perpetual Maintenance (Non Refundable)	10%	\$ 500.00	
Interment	10%	\$3,020.00	
Supply and Install Granite Desktop Headstone	10%	\$2620.00	
Etching or Font 0 - 100 Characters 100 - 200 Characters	10%	\$500.00 \$750.00	Optional for images Vitreous, Ceramic or etched images - POA
Supply & Install Additional Memorial Plaque	10%	\$300.00	ADDITIONAL EXTRAS
Up to two flower holders \$150 each	10%	150.00	
Additional Ashes Placement	10%	\$200.00	
Administration for each additional placement	10%	\$200.00	

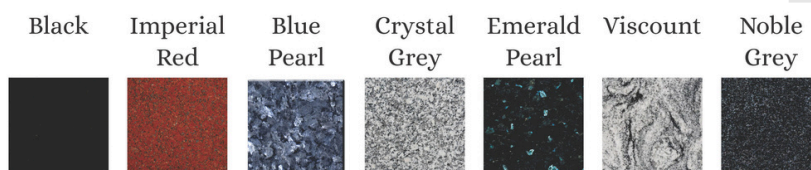

## KANDANGA CEMETERY ASSOCIATION INC

PO Box 102  
2325 Mary Valley Road  
KANDANGA QLD 4570  
Phone: 0438843195  
Email: secretary@kandangacemetery.com.au

Prices include Australian Standard concrete foundations & installation as per Australian Standard AS4204/2019

Fees reviewed annually 1 January - Current 01.01.26 - 31.12.26



# Section B Burial Option

Desktop Headstones mark the location of a burial and can be dedicated to one or two family members, commemorated with a granite marker. Additionally, up to five ash inurnments can be included, each with a bronze plaque.

One or two flower inserts can be added to the desktop headstone. The base is angled to accommodate the natural slope of the ground.

All monuments and plaques are coordinated by Kandanga Cemetery Association

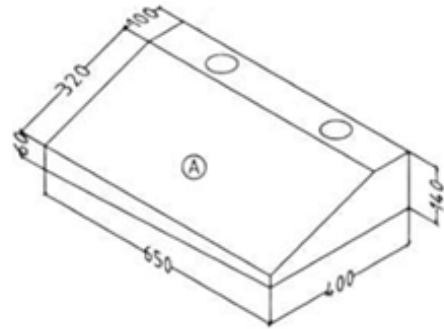

## Section B Burial Option

Description	GST	Fee incl GST	Total at time of application
-------------	-----	--------------	------------------------------

No additional plots are available. Additional burials and/or inurnments permitted in existing plots with the permission of the burial rights holder.

Interment	10%	\$3,020.00	
Supply and Install Granite Headstone	10%	\$3,200.00	
Granite or Concrete foundation on installation 600mm X 900mm	10%	\$ POA	
Up to two flower holders \$150 each	10%	\$150.00	
Etching or Font 0 - 100 Characters   100 - 200 Characters	10%	\$500.00 \$750.00	
Supply & Install Additional Memorial Plaque	10%	\$300.00	
Additional Ashes Placement	10%	\$200.00	
Administration for each additional placement	10%	\$200.00	

Optional for images:  
Vitreous, Ceramic or  
etched images - price  
on quotation

**ADDITIONAL  
EXTRAS**

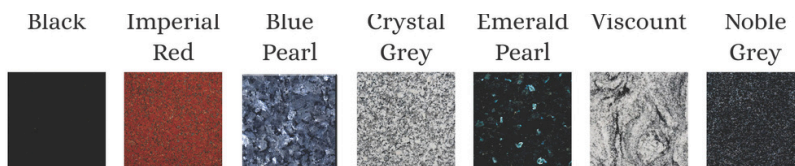

## KANDANGA CEMETERY ASSOCIATION INC

PO Box 102  
2325 Mary Valley Road  
KANDANGA QLD 4570  
Phone: 0438843195  
Email: secretary@kandangacemetery.com.au

Prices include Australian Standard concrete foundations & installation as per Australian Standard AS4204/2019

Fees reviewed annually 1 January - Current 01.01.26 - 31.12.26



# Section C Burial Option

Desktop headstones mark the location of a burial and can be dedicated to one or two family members, commemorated with a granite marker. Additionally, up to five ash interments can be included, each with a bronze plaque.

One or two flower inserts can be added to the headstone. The base is angled to accommodate the natural slope of the ground.

All monuments and plaques are coordinated by Kandanga Cemetery Association

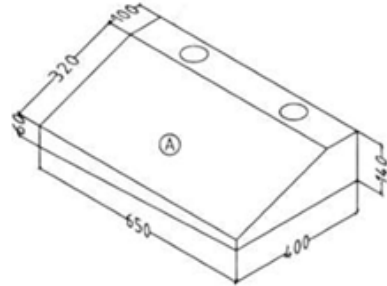

## Section C Burial Option

Description	GST	Fee incl GST	Total at time of application
Burial Rights Section C (Refundable)	N/A	\$900.00	
Perpetual Maintenance (Non Refundable)	10%	\$450.00	
Interment	10%	\$3,020.00	
Supply & Install Granite Desktop Headstone	10%	\$2,620.00	
Up to two flower pots \$150 each	10%	\$150.00	Optional for images: Vitreous, Ceramic or etched images Price on quotation
Etching or Font 0 - 100 Characters   100 - 200 Characters	10%	\$500.00 \$750.00	
Supply & Install Additional Memorial Plaque	10%	\$300.00	<b>ADDITIONAL EXTRAS</b>
Additional Ashes Placement	10%	\$200.00	
Administration for each additional placement	10%	\$200.00	

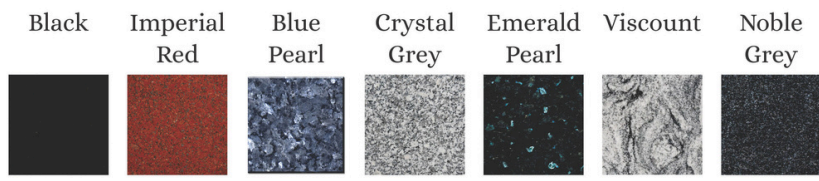

## KANDANGA CEMETERY ASSOCIATION INC

PO Box 102  
2325 Mary Valley Road  
KANDANGA QLD 4570  
Phone: 0438843195  
Email: secretary@kandangacemetery.com.au

Prices include Australian Standard concrete foundations & installation as per Australian Standard AS4204/2019

Fees reviewed annually 1 January - Current 01.01.26 - 31.12.26



# Section D Burial Option

This section is designated for traditional burials, marked with upright granite headstones. Each site can accommodate the burial of one or two family members and may include up to five additional ashes inurnments, commemorated with individual bronze plaques.

Headstones are set on a subtly angled base to follow the natural slope of the land, preserving the harmony of the landscape. An optional vase insert can be included within the base of the headstone.

All monuments and plaques are coordinated by Kandanga Cemetery Association

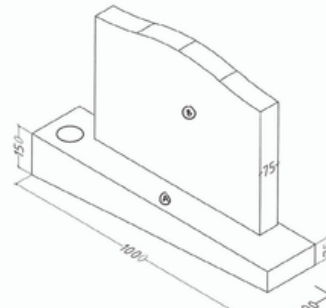
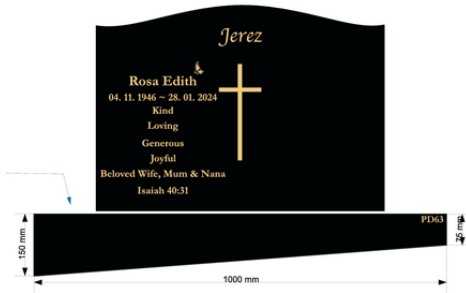

## Section D Burial Option

Description	GST	Fee incl GST	Total at time of application
Burial Rights to Plot Section D (Refundable)	N/A	\$1,200.00	
Perpetual Maintenance (Non Refundable)	10%	\$ 600.00	
Interment	10%	\$3,020.00	
Supply & Install Granite Headstone and Base	10%	\$2,930.00	
One flower pot on highside of base	10%	\$150.00	
Etching or Font			Optional for images: Vitreous, Ceramic or etched images - price on quotation
0 - 100 Characters	10%	\$500.00	
100 - 200 Characters	10%	\$750.00	
Supply & Install Additional Memorial Bronze Plaque on base of Monument	10%	\$300.00	<b>ADDITIONAL EXTRAS</b>
Additional Ashes Placement	10%	\$200.00	
Administration for each additional placement	10%	\$200.00	

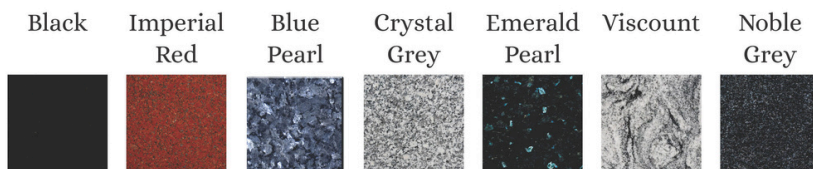

## KANDANGA CEMETERY ASSOCIATION INC

PO Box 102  
2325 Mary Valley Road  
KANDANGA QLD 4570  
Phone: 0438843195  
Email: secretary@kandangacemetery.com.au

Prices include Australian Standard concrete foundations & installation as per Australian Standard AS4204/2019

Fees reviewed annually 1 January - Current 01.01.26 - 31.12.26



# Section E Burial Option

Upright memorial headstones are where burials are placed. These headstones are placed directly onto the beam. The placement can be dedicated to burial of one or two family members with a granite marker. Up to 3 memorial plaques / ashes placements can be added on the beam in front of the headstone.

All monuments and plaques are coordinated by Kandanga Cemetery Association



## Section E Burial Option

Description	GST	Fee incl GST	Total at time of application
Burial Rights Section E (Refundable)	N/A	\$1,000.00	
Perpetual Maintenance (Non Refundable)	10%	\$ 500.00	
Interment	10%	\$3,020.00	
Supply & Install Granite or Marble Headstone Teardrop shape size 650mmH X 700mmW X 75mm	10%	\$2,120.00	
Etching or Engraving 0 - 100 Characters	10%	\$500.00	Optional for images: Vitreous, Ceramic or etched images - price on quotation
100 - 200 Characters		\$750.00	
Supply & Install Additional Memorial Plaque	10%	\$300.00	<b>ADDITIONAL EXTRAS</b>
Additional Ashes Placement	10%	\$200.00	
Administration for each additional placement	10%	\$200.00	

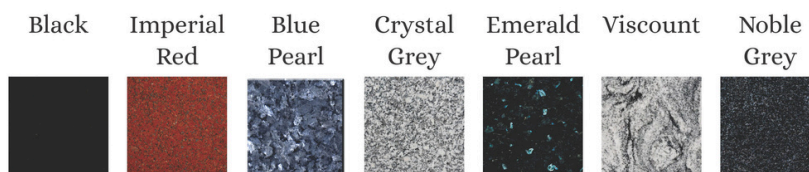

## KANDANGA CEMETERY ASSOCIATION INC

PO Box 102  
2325 Mary Valley Road  
KANDANGA QLD 4570  
Phone: 0438843195  
Email: secretary@kandangacemetery.com.au

Prices include Australian Standard concrete foundations & installation as per Australian Standard AS4204/2019

Fees reviewed annually 1 January - Current 01.01.26 - 31.12.26



*Honour Reflection*

# Family Reflection Gardens Memorial or Ashes Sites

Family Gardens Memorials offer a dedicated space exclusively for one family. Each garden includes a granite marker engraved with the family name, installed at the time of dedication. Up to ten individual memorials and/or ashes inurnments can be accommodated. The granite memorials are set in harmony with the natural slope of the landscape, maintaining a serene and respectful appearance.

All monuments and plaques are coordinated by Kandanga Cemetery Association



## Combined Family Garden Memorial or Ashes Sites

Description	GST	Fee incl GST	Total at time of application
Rights to a Family Site (Non refundable)	N/A	\$1,000.00	
Perpetual Maintenance (Non refundable)	10%	\$ 500.00	
Supply & Install Granite Family Marker (set on concrete foundation) Includes etching of family name as above Black Granite or Noble Grey only 850mm X 600mm X100mm   Base: 900mm X 200mm X 75mm	10%	\$2,510.00	
Font 0 - 100 Characters	10%	\$500.00	Optional for images: Vitrous, Ceramic or etched images - price on quotation
Font 100 - 200 Characters	10%	\$750.00	
Supply & Install Granite Memorial Desk Single Desk 180mm x 140mm Double Desk 280 x 140mm	10% 10%	\$385.00 \$605.00	<b>ADDITIONAL EXTRAS</b>
Ashes placement - per Interment	10%	\$300	



Black

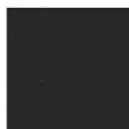

Noble  
Grey

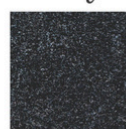

## KANDANGA CEMETERY ASSOCIATION INC

PO Box 102  
2325 Mary Valley Road  
KANDANGA QLD 4570  
Phone: 0438843195  
Email: secretary@kandangacemetery.com.au

Prices include Australian Standard concrete foundations & installation as per Australian Standard AS4204/2019

Fees reviewed annually 1 January - Current 01.01.26 - 31.12.26



# Avenue of Remembrance Memorial or Ashes Sites

The Avenue of Remembrance provides a peaceful, avenue of trees offering a serene setting for the placement of memorial plaques and/or inurnment of ashes. Each dedicated space honours one or two family members and includes a granite memorial set in harmony with the natural slope of the landscape, maintaining a serene and respectful appearance.

All monuments and plaques are coordinated by Kandanga Cemetery Association



400 high x 800 wide

## Avenue of Remembrance Memorial or Ashes Sites

Description	GST	Fee incl GST	Total at time of application
Avenue of Remembrance Rights (Refundable)	N/A	\$730.00	
Perpetual Maintenance (Non Refundable)	10%	\$370.00	
<b>Supply &amp; Install</b>			
Granite Marker suitable for single or double Set on concrete foundation Black Granite or Noble Grey 800mmW X 400mmH X 75mm	10%	\$1560.00	
Etching or Font			Optional for images: Vitreous, Ceramic or etched images - price on quotation
0 - 100 Characters	10%	\$500.00	
100 - 200 Characters		\$750.00	
Ashes Placement per interment	10%	\$300.00	<b>ADDITIONAL EXTRAS</b>

Black



Noble Grey



## KANDANGA CEMETERY ASSOCIATION INC

PO Box 102  
2325 Mary Valley Road  
KANDANGA QLD 4570  
Phone: 0438843195  
Email: secretary@kandangacemetery.com.au

Prices include Australian Standard concrete foundations & installation as per Australian Standard AS4204/2019

Fees reviewed annually 1 January - Current 01.01.26 - 31.12.26



# Memorial Gardens A & B Ashes Option

Memorial Gardens provide a contemporary alternative to traditional wall niches. This inurnment option allows for the respectful placement of ashes within a landscaped garden bed, commemorated by a memorial plaque, which is included in the cost of the plot.

All monuments and plaques are coordinated by Kandanga Cemetery Association

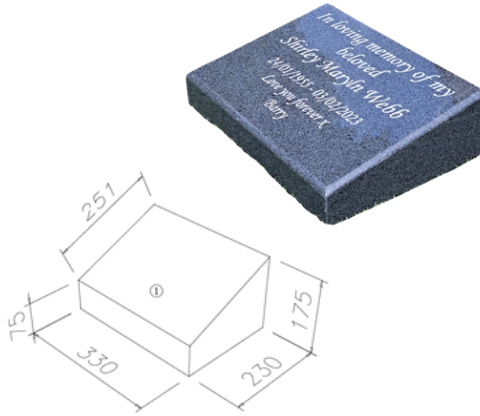

## Memorial Garden Ashes Option

Description	GST	Fee incl GST	Total at time of application
Rights to a Memorial Garden (Refundable)	N/A	\$600.00	
Perpetual Maintenance (Non Refundable)	10%	\$300.00	
Supply & Install Granite Desktop Marker 330mm wide X 230mm deep X 251 face Front height 75mm Back height 175mm	10%	POA	
Etching or Font 0 - 100 Characters	10%	\$500.00	Optional Extras Vitreous, Ceramic or etched images - price on quotation
100 - 200 Characters		\$750.00	
Ashes Placement	10%	\$300.00	

Black



Noble  
Grey

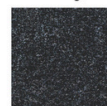

## KANDANGA CEMETERY ASSOCIATION INC

PO Box 102  
2325 Mary Valley Road  
KANDANGA QLD 4570  
Phone: 0438843195  
Email: secretary@kandangacemetery.com.au

Prices include Australian Standard concrete foundations & installation as per Australian Standard AS4204/2019

Fees reviewed annually 1 January - Current 01.01.26 - 31.12.26



*Honour Reflection*

# Columbarium Ashes Option

Crafted from durable brick, Columbarium Walls offer a low-maintenance alternative to traditional burial, while maintaining a respectful and serene environment for reflection. Each niche is designed to respectfully house single or double inurnments, offering families a serene and well-maintained space for remembrance within the cemetery grounds. Plaques are crafted in Bronze with gold lettering

Walls A, B & C are dedicated to ashes inurnments with Memorial Plaques  
Walls D & E are Memorial Plaques only

All monuments and plaques are coordinated by Kandanga Cemetery Association



## Columbarium Wall

Description	GST	Fee incl GST	Total at time of application
Rights to Columbarium Wall A,B,C Single Ashes & Memorial 140mm x 140mm (Refundable)		\$410.00	
Perpetual Maintenance (Non Refundable)	N/A 10%	\$210.00	
Rights to Columbarium Wall A,B,C Double Ashes & Memorial 280mm x 140mm (Refundable)		\$730.00 \$370.00	
Perpetual Maintenance (Non Refundable)	10%		
Rights to Columbarium Wall D - Single Memorial Plaque only 140mm x 140mm (Refundable)	N/A	\$130.00	
Perpetual Maintenance (Non Refundable)	10%	\$ 70.00	
Rights to Columbarium Wall D & E - Double Memorial Plaque Only 280mm x 140mm (Refundable)	N/A 10%	\$260.00 \$140.00	
Perpetual Maintenance (Non Refundable)			
Walls A,B,C Inurnment & Placing of Ashes & Fixing of Plaque	10%	\$200.00	
Walls D & E Fixing of Plaque	10%	\$200.00	
Suspended Vase	10%	\$90.00	ADDITIONAL EXTRAS